

## Table of contents

<b>1</b>	<b>Product description</b>	<b>2</b>
1.1	Intended use and operation	2
1.2	Contraindications	2
1.3	Technical data, Vacuson 40/60	2
1.4	Ambient conditions	3
1.5	Warranty coverage	3
<b>2</b>	<b>Explanation of symbols</b>	<b>4</b>
<b>3</b>	<b>Safety information</b>	<b>5</b>
3.1	EMC Manufacturer's Declaration of Conformity	5
3.2	Modification and misuse	5
3.3	Essential requirements	5
3.4	During use	5
<b>4</b>	<b>Scope of delivery</b>	<b>6</b>
<b>5</b>	<b>Device overview</b>	<b>7</b>
<b>6</b>	<b>Startup</b>	<b>8</b>
6.1	Device setup	8
6.2	Connection to the power supply	8
6.3	Preparation of secretion jars	9
6.4	Preparing the MONOKIT secretion jar system	10
6.5	Device preparation	11
<b>7</b>	<b>Operation</b>	<b>14</b>
7.1	Switching device on and off (Mains switch)	14
7.2	Pump activation by pneumatic pedal	14
7.3	Variagate with Vario-AIR-Pedal	14
7.4	Regulating suction process	14
7.5	Emptying secretion jar	15
7.6	Function control	15
<b>8</b>	<b>Cleaning, disinfection and sterilization</b>	<b>16</b>
8.1	Control unit and pneumatic pedal	16
8.2	Secretion jar and jar lid	16
8.3	MONOKIT secretion jar with disposable inlay pouch	16
8.4	Bacteria filter	16
8.5	Silicone tubes	16
8.6	Cannulas and cannula handlebar	17
8.7	Quiver	17
<b>9</b>	<b>Maintenance</b>	<b>18</b>
9.1	Replacing the control unit fuse	18
9.2	Safety inspections	18
9.3	Bacteria filter	19
9.4	Secretion jar	19
9.5	Function control of float gauge valve	19
9.6	Disassembly of the Overflow Protection System	20
9.7	Seals and tubes	21
<b>10</b>	<b>Malfunction and troubleshooting</b>	<b>22</b>
<b>11</b>	<b>Accessories and spare parts</b>	<b>23</b>
<b>12</b>	<b>Information on disposal</b>	<b>24</b>

# 1 Product description

## 1.1 Intended use and operation

The Vacuson 40/60 is a suction pump for the use in medical, chemical and laboratory environments. In the medical field the suction pump is used as following:

- Surgery pump
- Lipectomy pump for subcutaneous liposuction
- Curettage pump for the aspiration of uterine tissue in Gynecology
- Universal pump
- Extractor pump in obstetrics

The Vacuson 40/60 function is to aspirate fluids and secretions. The suction power of the pump can be adjusted continuously by a vacuum regulator and can be monitored by the pressure gauge.

Patient population is not restricted in respect of age, weight and gender.

Configuration and operation of the Vacuson 40/60 shall be performed only by surgeons or highly qualified and trained medical personnel.

## 1.2 Contraindications

- a) Infected wounds have poorly vascularized and necrotic tissue.
- b) Poor physical health of patient.
- c) Patients who underwent crash dieting immediately prior to consultation.
- d) Morbid (mega-liposuction controversial due to higher risk of mortality from fluid shifts).
- e) Relative or absolute contraindications may result from the general medical findings or in special cases in which the patients risk for motor-driven tools is significantly increased.

Cases described in the relevant literature must be taken into account.

## 1.3 Technical data, Vacuson 40/60

	Vacuson 40	Vacuson 60
<b>Voltage:</b>	115 V~at 60 Hz; 230 V~at 50 Hz	115 V~at 60 Hz; 230 V~at 50 Hz
<b>Power consumption:</b>	max. 180 VA for 115 V version max. 170 VA for 230 V version	max. 370 VA for 115 V version max. 400 VA for 230 V version
<b>Fuses for 115 V model:</b>	2 x T4 AL, 250 V AC	2 x T4 AL, 250 V AC
<b>Fuses for 230 V model:</b>	2 x T2 AL, 250 V AC	2 x T2 AL, 250 V AC
<b>Protection class:</b>	Class I	Class I
<b>Applied part:</b>	Type BF	Type BF
<b>Adjustable vacuum:</b>	- 0.9 bar at 686 mmHG	- 0.9 bar at 675 mmHG
<b>Dimensions, W x H x D:</b>	360 x 300 x 280 mm	360 x 300 x 280 mm
<b>Weight:</b>	10 kg	12 kg
<b>Accuracy limit, Manometer:</b>	± 5 %	± 5 %
<b>Suction Pump Capacity:</b>	40 l/min	60 l/min

## 1.4 Ambient conditions

	Transport and storage:	Operation:
Relative humidity:	Max. 90 %	Max. 80 %
Temperature:	0 – 60°C, (32 – 140°F)	10 – 30°C, (50 – 86°F)
Atmospheric pressure:	700 – 1060 hPa	800 – 1060 hPa

















EN

## 1.5 Warranty coverage

Purchasing a Vacuson 40 or Vacuson 60 suction pump entitles you to a 1-year warranty. If you return the warranty card for registration within four weeks of the date of purchase, warranty coverage will be extended for a further **6 month**.

Consumable parts are not covered by the warranty. Improper use or repair, or failure to observe these instructions, relieve us from any obligations arising from warranty provisions or other claims.

## 2 Explanation of symbols

	Important information		Autoclavable at 135°C
	Warning		Suitable for thermal disinfection
	Date of manufacturing		Protective ground
	Manufacturer		Observe the instructions for use
	Type BF applied part is the filling tube with connected instruments		Electrical and electronic devices that have reached the end of their service life comprise hazardous waste and may not be disposed of together with household waste. Valid local disposal regulations apply.
<b>IPX8</b>	Protection continual submerging.	<b>SN</b>	Symbol indicating the serial number with the date of manufacture (year/month).
	Pedal	<b>REF</b>	Symbol indicating the order number.
	Date of expiry	<b>LOT</b>	Symbol indicating the lot number.
<b>CE</b> 0197	CE symbol with notified body		Not for reuse
	Warning: Hot surfaces		Equipotential (Equality of potential)
	Air-Exhaust port		

### 3 Safety information

Your safety, the safety of your team, and of course that of your patients is very important to us. It is therefore essential to bear the following information in mind:

Every use of the Vacuson 40/60 different to the product description defined in „chapter Intended use and operation“, causes risks for patients and trained personnel. If physical examinations and therapies are carried out without use of the devices then the devices must be removed from the place of treatment. Avoid any connection or close adjacency to other devices.

#### 3.1 EMC Manufacturer’s Declaration of Conformity

The use of (RF) Radio Frequency emitting devices and equipment as well as the occurrence of negative environmental factors in the close area of the Vacuson 40/60 may cause unexpected or adverse operation. The connection or the placing of other devices in close vicinity is not allowed.

The Product is suitable for use in establishments of the industrial sector and hospitals. When used in the domestic establishments, this unit may not provide adequate protection for radio services. The user must take remedial measures such as implementation or reorientation of the product.

Use only accessories and cables as specified in the product description. Further observe the EMC manufacturer declaration of conformity.

#### 3.2 Modification and misuse



- Modification or manipulation of the Vacuson 40/60 suction pumps and its accessories is prohibited. The manufacturer is not liable for any damages resulting from unauthorized modifications or manipulations. The warranty will be canceled.
- Use of the Vacuson 40/60 suction pumps outside the indications described in Section 1.1 is prohibited. The user or operator is solely responsible for any such use.

#### 3.3 Essential requirements



The Vacuson 40/60 suction pumps may only be operated under constant supervision of qualified and trained personnel!



Improper use or repair of the device and failure to observe these instructions relieve us from any obligation arising from warranty provisions or other claims!



The use of third-party products is the responsibility of the operator. Functionality and patient safety cannot be guaranteed with third-party accessories.



Prior to using the device, before startup, and before operation, the user must always ensure that the device and accessories are in good working order and are clean, sterile and operational.



Repairs may only be performed by authorized NOUVAG service technicians.

#### 3.4 During use



The device is not sterile on delivery. All sterilizable parts must be sterilized before use (refer to chapter 8 “Cleaning, disinfection and sterilization”).



At the choosing of the instrument the operator has to make sure it’s biocompatible, according to EN ISO 10993.



While in operation the control unit of the Vacuson 40/60 suction pumps must be at least 1 meter above ground.





















Do not use the device in the vicinity of flammable mixtures.



In extreme cases, the device may heat up excessively.

## 4 Scope of delivery

REF	Description	Quantity
<b>Vacuson 40 set (REF 4227-115 V/4227-230 V)</b>		
4275	Control unit Vacuson 40 -----	1
 15012	ON/OFF-pneumatic pedal to switch the device on and off-----	1
 4076	Suction tube 8 x 3 x 1700 mm, silicone, sterilizable -----	1
 4246	Bacteria filter for suction pump, Ø 64 mm, PTFE, hydrophobe, disposable -----	10
31997	Operating instructions on CD-ROM -----	1
<b>Vacuson 60 set (REF 4237-115 V/4237-230 V)</b>		
4280	Control unit Vacuson 60 -----	1
 15012	ON/OFF-pneumatic pedal to switch the device on and off -----	1
 4076	Suction tube 8 x 3 x 1700 mm, silicone, sterilizable -----	1
 4246	Bacteria filter for suction pump, Ø 64 mm, PTFE, hydrophobe, disposable -----	10
31997	Operating instructions on CD-ROM -----	1
<b>Optional:</b>		
 4155	Connecting tube, 8 x 3 x 400 mm, from bacteria filter to secretion jar, silicone, sterilisable-----	1
 4190	Connecting tube, 8 x 3 x 500 mm, from bacteria filter to secretion jar, silicone, sterilisable -----	1
 6026	Disposable suction tube 9 x 6.5 x 4000 mm, sterile -----	1
4242	Vario-AIR-Pedal -----	1
 4052	Secretion jar, 2 liter, polysulfone, sterilisable, including operation manual -----	1
 4245	Secretion jar, 5 liter, polysulfone, sterilisable, including operation manual-----	1
 4058	Secretion jar lid with overflow protection system for 2 and 5 liter secretion jars, sterilisable -----	1
 4035	2 liter disposable secretion pouches including lid for MONOKIT system-----	50
 4036	2 liter inlay jar of MONOKIT system -----	1
 4037	Mounting bracket of MONOKIT system for mounting secretion jars on Vacuson pump -----	1
 4043	Quiver, sterilisable, 30 cm length, with suspension device -----	1
 4044	Quiver, sterilisable, 40 cm length, with suspension device-----	1
 4130	Two way tap to switch between the two secretion jars, including connection tube 8 x 3 x 400 mm-----	1
 28535	Angled connector (VACUUM) for more convenient tube connection of the suction tube -----	1

## 5 Device overview

### Front view



EN

### Rear view of Vacuson 40

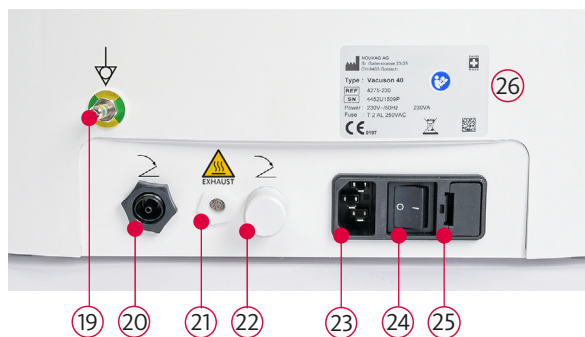

### Rear view of Vacuson 60

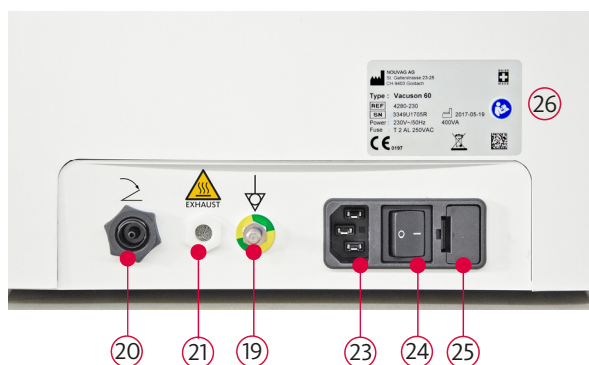

1. Suction cannula (optional)
2. Filling tube (1700 mm), silicone
3. Secretion jar (Example 2 Liter)
4. Overflow protection system
5. Secretion jar lid
6. Connection for connecting tube (VACUUM)
7. Turn an tilting lever
8. Connection for filling tube (PATIENT)
9. Connecting tube, silicone
10. Bacteria filter
11. Two way cock (optional, REF 4130)
12. Carrying handle
13. Secretion jar mount
14. Ready indication, LED
15. Manometer
16. ON/OFF pneumatic pedal
17. Vacuum regulator (VACUUM)
18. Ventilation intake
19. Potential equalization
20. Port for pneumatic ON/OFF-pedal
21. Air exhaust port (EXHAUST)
22. Connection for VARIO-Air pedal
23. Power plug socket
24. Main switch ON/OFF
25. Fuse compartment
26. Type plate with type designation, reference number, serial number, information on power supply and device fuse.

## 6 Startup

### 6.1 Device setup

- Installations-Layout



- Place the Vacuson 40/60 suction pump and all required accessories and instruments on an even, non-slip surface and make sure you have good access to all controls.
- The installation of the device in close proximity to other devices is prohibited due to EMC – please see section 3.1 and the manufacturer's EMC declaration in the appendix of this manual.
- Do not allow the operating range of the device (including cable) and the connected instrument to be compromised by limiting factors.
- The manometer must be fully visible at all times.
- The On/Off-AIR-Pedal must be placed within stepping distance between the patient and the surgeon.
- It must be explicitly ensured that no objects can fall on the pedal.
- The power plug at the rear of the device must be accessible at all times.
- The ventilation slots at the housings bottom and sideways of the Vacuson 40/60 must be kept clear in order to prevent temperature from becoming excessive.
- While in operation the Vacuson 40/60 suction pumps must be at least 1 meter above ground.

### 6.2 Connection to the power supply



Before switching on, make sure that the power supply unit of the device matches the country's specific service voltage!

The power supply unit of the Vacuson 40/60 pumps is not swichable to the country specific service voltage. The device has to be ordered according to the country specific service voltage.



In order to prevent the risk of an electric shock, the device may only be connected to a power network with a PE protective ground conductor.



Zum Anschluss des Gerätes an die Spannungsversorgung darf nur ein geprüftes Netzkabel verwendet werden.

The power plug socket is located at the rear of the device.



### 6.3 Preparation of secretion jars

1. Hold open secretion jars (2 or 5 liter) or MONOKIT-jar available.



EN

2. Press jar lid with turn and tilting lever in open-position firmly onto the jar (the latch of the locking system is in open-position).



3. Rotate turn and tilting lever by 180° (turn and tilting lever now facing away from the grasp). Make sure the gripper catches the rim of the jar.



4. Flap down turn and tilting lever into the designated groove.



## 6.4 Preparing the MONOKIT secretion jar system

1. Hold ready MONOKIT secretion jar with disposable inlay pouch and mounting bracket.



2. Insert the disposable inlay pouch into the MONOKIT secretion jar and make sure the tube connector is on the lid.



3. Place bottle holder ring in the secretion jar bracket of the Vacuson pump.



4. Fix connecting tube (VACUUM) and suction tube (PATIENT) on the tube connections at the MONOKIT jar lid.

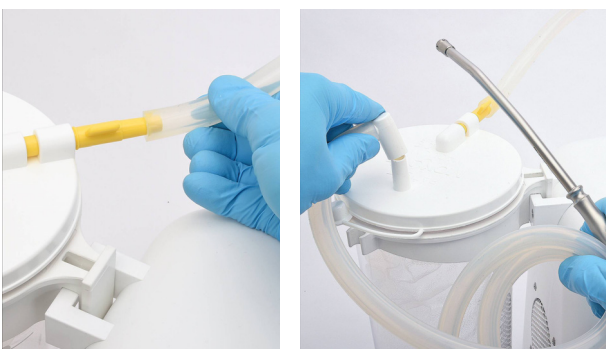

## 6.5 Device preparation

1. Prior to use all sterilizable parts (Tubes, Cannulas, Cannula handlebar, char lid and bottles) must be sterilized.



2. Attach secretion jars with mounted and locked lid to the device.



3. Lay the pneumatic pedal on the floor and plug the connection tube into the port for the pneumatic pedal.



4. The Vario-AIR-Pedal (optional) is connected to the air inlet port at the control unit by the connection tube. If not in use the port is covered with a lid. Make sure to cover the port again when Vario-AIR-Pedal is not connected.



- Attach the short connection tube (400 mm) on one end with the bacteria filter and the other end with the narrow connector (VACUUM) of the jar lid.



- Attach the filling tube (1700 mm) on one end with the angled connector (optional REF 28535) and the other end of the tube with the instrument.



- Mount connection tube with bacteria filter onto the intake nozzle at the top of the Vacuson pump. Graft the other end of the connection tube with the narrow connector onto the smaller nozzle of the secretion jar (VACUUM).



- Graft the angled connector (optional REF 28535) of the filling tube (1700 mm) onto the wider nozzle (PATIENT) of the secretion jar. Hang the other end of the filling tube with the instrument into the quiver.



9. Screw suction cannula (optional) onto the cannula handlebar (Vacuson 60, Liposuction) and hang it back into the quiver.



10. Connect the device socket with the wall socket, using the devices power cord.



Before switching on, make sure that the power supply of the device matches the country's specific service voltage!

## 7 Operation

### 7.1 Switching device on and off (Mains switch)



Use the power switch "I/O", at the rear of the device, to switch the device on and off. The standby is signaled by the LED status light at front of the device. The device can be switched off at any time, irrespective of any procedure for device switch-off.



The pneumatic ON/OFF pedal has to be connected, because the pump is only starting by a press on the pedal.

### 7.2 Pump activation by pneumatic pedal



The included standard pneumatic ON/OFF-pedal when pushed activates a switch in the Vacuson pump, to switch the pump on and off. This is maintained by an air pillow. After the device was switched on, the pneumatic pedal has to be pressed to activate the pump and generate vacuum. Pressed again the pump is deactivated. The pump can only be activated by the pedal. The last used state before switch-off stays active.

### 7.3 Variegate with Vario-AIR-Pedal



Handsfree regulation of the vacuum can be maintained by using the Vario-AIR-Pedal (optional, REF 4242). When pressed, the Vario-AIR-Pedal opens a valve and the vacuum is reduced by forced ventilation of the pressure system. The more the pedal is pressed the less vacuum can build up, hence the suction performance decreases. If the suction performance is controlled by the Vario-AIR-Pedal, the Vacuum Controller on the front side of the device ideally remains in maximal position. The Vario-AIR-Pedal is normally used together with the pneumatic pedal.

### 7.4 Regulating suction process



The suction process is regulated by the Vacuum controller at the front side of the device.

*Rotate clockwise: Vacuum increases, suction performance is enhanced.*  
*Rotating anticlockwise: Vacuum decreases, suction performance is reduced.*

#### Establishing airtightness of the suction system:

1. Turn Vacuum Controller anticlockwise all the way to the stop (equivalent to vacuum minimum).
2. Switch on mains switch (I/O) of the pump and press On/Off pedal shortly. Pump is running and building up vacuum.
3. Crimp suction tube to generate maximal air-tightness of the suction system.
4. Turn Vacuum Controller clockwise (equivalent to vacuum maximum).
5. Wait for maximum build up of vacuum (equivalent to  $\geq -0.9$  bar).
6. Now by turning the Vacuum Controller the suction performance can be regulated steplessly from 0 to  $-0.9$  bar.



The vacuum manometer shows the current vacuum in the device – due to the connection of tubes and adapters, the effective vacuum at the cannula can deviate from the displayed value.

## 7.5 Emptying secretion jar

The jar lid of the secretion jar is equipped with an overflow protection system to prevent the vacuum system from being flooded by secretion fluids at high filling levels of the secretion jar. Therefore a float gauge is responsible. At high filling levels of the secretion jar and the resulting locking of the overflow protection system the secretion jar has to be emptied or replaced by another secretion jar.

1. Switch off suction pump.
2. Disconnect tubes from the secretion jar lid.
3. Unhinge full secretion jar from the secretion jar mount and dispose of secretion fluids according to national disposal regulations.
4. Procure used secretion jars to the reprocessing cycle.
5. Connect suspended tubes with new, ready to use secretion jar.

## 7.6 Function control

To obtain trouble-free operation of the suction pump all the components and functions of the pump system have to be tested prior every assignment.

### General functions:

1. Use the power switch "I/O", at the rear of the device, to switch the device on, LED is illuminated.
2. Device fan is running.

### Suction pump with pneumatic pedal:

1. Use the power switch "I/O", at the rear of the device, to switch the device on, LED is illuminated.
2. Device fan is running.
3. Hold hand in front of the «Exhaust» (Rear of the device). Airflow is perceptible.
4. Press pneumatic pedal shortly to activate the suction pump.
5. Turn Vacuum Controller clockwise (equivalent to vacuum maximum).
6. Control vacuum intensity at the opening of the cannula. Strong suction performance.
7. Turn Vacuum Controller anticlockwise all the way to the stop (equivalent to vacuum minimum).
8. Control vacuum intensity at the opening of the cannula. Weak suction performance.
9. Use the power switch "I/O", at the rear of the device, to switch off device, LED is not illuminated.

### Suction pump with pneumatic pedal and Vario-AIR-Pedal:

1. Use the power switch "I/O", at the rear of the device, to switch the device on, LED is illuminated.
2. Device fan is running.
3. Hold hand in front of the «Exhaust» (Rear of the device). Airflow is perceptible.
4. Press pneumatic pedal shortly to activate the suction pump.
5. Turn Vacuum Controller clockwise (equivalent to vacuum maximum).
6. Control vacuum intensity at the cannulas opening. Strong suction performance.
7. Press Vario-AIR-Pedal. The more it is pressed, the weaker the suction performance at the cannula.
8. Turn Vacuum Controller anticlockwise all the way to the stop (equivalent to vacuum minimum).
9. Control vacuum intensity at the cannulas opening. Weak suction performance.
10. Press Vario-AIR-Pedal. The more it is pressed, the weaker the suction performance at the cannula. The suction performance now is not perceptible anymore.
11. Use the power switch "I/O", at the rear of the device, to switch off device, LED is not illuminated.

### Malfunctions and troubleshooting:

To solve problems refer to chapter 10 "Malfunctions and troubleshooting".

## 8 Cleaning, disinfection and sterilization

The following points in particular are important with regard to caring for the material:



- Perform cleaning, disinfection and sterilization after every treatment!

- Always autoclave the material in sterilization packaging.

- Make sure that sterilization packaging is no more than 80 % full.



- Always autoclave the material at 135°C for at least 5 minutes.

- If sterilized material is not used immediately, the material packaging must be labeled with the sterilization date.

- Nouvag AG recommends including a sterility indicator.

### 8.1 Control unit and pneumatic pedal

Control unit and pneumatic pedal do not come into contact with the patient.

Wipe the outside using micro-biologically tested surface disinfectant or a 70 % isopropyl solution. The front plate of the control unit is sealed for this purpose and can be wiped clean.

### 8.2 Secretion jar and jar lid

The reprocessing instructions for the secretion jar and jar lid is provided in the operating instructions delivered with the secretion jar.

### 8.3 MONOKIT secretion jar with disposable inlay pouch

The disposable MONOKIT inlay pouches are not to be reprocessed. They have to be discarded off expertly. For reprocessing the reusable outer container (secretion jar) please refer to the operation manual delivered with the product.

### 8.4 Bacteria filter

The bacteria filter located on top of the Vacuson pump is a one way product and cannot be cleaned or sterilized.

A periodical replacement of the bacteria filter is recommended after 8 hours of use, but definitely after it came into contact with foam or infectious material.



After contact with watery solutions the bacteria filter locks down, because of its hydrophobic characteristic, to protect the pump from clogging. Hence the further operation of the pump is not possible. The bacteria filter has to be replaced.

### 8.5 Silicone tubes

REF 4075, connection tube 8 x 3 x 400 mm from bacteria filter to secretion jar, silicone, sterilizable

REF 4076, suction tube 8 x 3 x 1700 mm, from secretion jar to suction cannula, silicone, sterilizable

Reprocessing restrictions	Frequent reprocessing of the silicon tubes has only a limited impact. The end of the product service life is normally determined by wear and damage through use.
---------------------------	--

INSTRUCTIONS	
At location of use	No special requirements.
Storage and transport	No special requirements. Long holding times before reprocessing have to be avoided due to surface drying.
Preparation for cleaning	No special requirements.



<b>Automatic cleaning and disinfection</b>	Equipment: Washer-disinfector with a special load carrier that ensures the connection of tubes to the washer-disinfector for rinsing. Use only neutral cleaning agents for this purpose. 1. Place silicone tubes in the load carrier. 2. Set a cleaning cycle that offers sufficient cleaning and rinsing. Perform the final rinse with fully deionized water. 3. Perform a 10-minutes rinse cycle at 93°C to facilitate thermal disinfection. 4. When removing, check silicone tubes, to verify whether soiling is still visible. If necessary, repeat the cycle or clean manually.
<b>Manual cleaning</b>	Equipment: Neutral cleaning agent, soft brush, running, demineralized water (< 38°C) Procedure: 1. Rinse off and brush away surface soiling from the silicone tubes. 2. Rinse silicone tubes thoroughly under running water.
<b>Manual disinfection</b>	For manual disinfection, submerge silicone tubes in chlorinefree disinfection solution.
<b>Drying</b>	Allow silicone tubes to dry sufficiently in a drying cabinet.
<b>Inspection and maintenance</b>	Perform a visual inspection to check for damage, corrosion and wear.
<b>Packaging</b>	Individual: Pack silicone tubes in individual packaging for sterile items. Sets: Sort silicone tubes on trays intended for this purpose or place them on allpurpose sterilization trays.
<b>Sterilization</b>	 Autoclave in vacuum autoclave at 135°C for at least 5 minutes. When sterilizing several items during one sterilization cycle, do not exceed the maximum sterilizer load. A drying cycle must be added in case of autoclaves without a post-vacuum function. Allow the silicone tubes to dry in the bag for at least one hour at room temperature with the paper side facing upwards. * Temperature exposure times are based on country-specific guidelines and standards.
<b>Storage</b>	No special requirements. If sterilized silicone tubes are not used immediately after sterilization, the material packaging must be labeled with the sterilization date. Including a sterility indicator is recommended.

The effectiveness of the sterilization instructions provided above for reprocessing this medical product has been validated by Nouvag AG. The user is responsible for ensuring that the sterilization procedure performed achieves the required results. This requires validation and routine monitoring of the procedure. The staff member who completes the procedure bears sole responsibility for any deviation on his part from the instructions provided. Deviations necessitate revalidation of the effectiveness of the procedure as well as of the technical resilience of the reprocessed items with regard to the modified sterilization process.



- The tube set REF 6024 (optional) is delivered in sterile condition. It is determined for single use and may not be resterilized!
- Contaminated tube sets have to be disposed of expertly!



## 8.6 Cannulas and cannula handlebar

The optional cannulas and the cannula handlebar are in contact with the patient and therefore have to be reprocessed adequately.

The reprocessing instructions are in the operation instructions, delivered together with the cannula and handlebar.

## 8.7 Quiver

Clean quiver from debris and soiling. Use a clean, damp cloth and/or an appropriate brush with disinfection agent.

1. Attention, it's important to use a disinfection agent compatible with polycarbonate.
2. Pack quiver in individual packaging for sterile items (siehe DIN 58953).
3. Autoclave wrapped quiver **at 135°C for at least 5 minutes\***.
4. A drying cycle must be added in case of autoclaves without a post-vacuum function. Allow quiver to dry in the bag for at least one hour at room temperature with the paper side facing upwards.

If sterilized quiver is not used immediately after sterilization, the material packaging must be labeled with the sterilization date. Including a sterility indicator is recommended.

\* Temperature exposure times are based on country-specific guidelines and standards.

## 9 Maintenance

### 9.1 Replacing the control unit fuse

Users can replace faulty control unit fuses themselves. These are located at the rear of the device in the fuse slot beside the power switch:

- Unplug the power plug.
- Open the fuse slot using a screw driver.
- Replace defective fuses T 4 AL, 250 V AC (115 V model)/ T 2 AL, 250 V AC (230 V model).
- Slide the fuse holder back in and close the fuse slot.
- Plug in the power plug again.

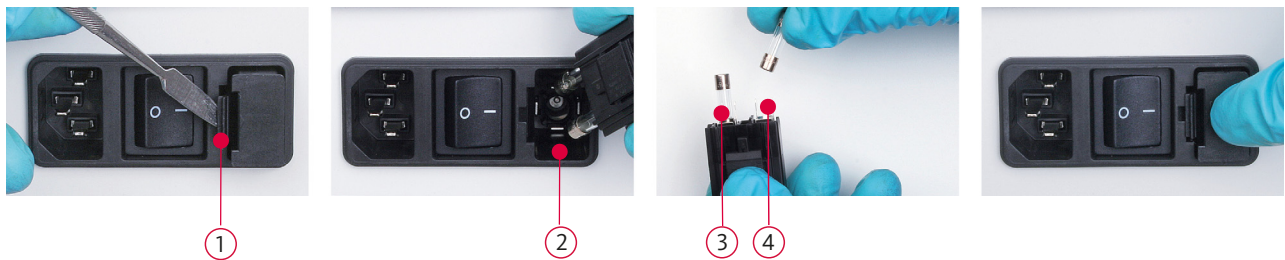

1. Fuse slot locking mechanism
2. Fuse slot
3. Fuse 1
4. Fuse 2

### 9.2 Safety inspections

The essential requirements have been defined and within the risk analysis assessed. The approved results have been filed in the Riskmanagement act with the manufacturer.

The performance of safety inspections on medical devices is required by law in several countries. The safety inspection is a regular safety check that is compulsory for those operating medical devices. The objective of this measure is to ensure that device defects and risks to patients, users or third parties are identified in time.

The STI (Safety technical inspection) for the Vacuson 40/60 shall be executed every 2 years by authorised experts. Results shall be documented.

The service manual, wiring diagrams, and descriptions are available upon request from Manufacturer.

NOUVAG AG offers a safety inspection service for its customers. Addresses can be found in the appendix of this operation manual under "Service centers". For further information please contact our technical service department.

Further international service centers are listed on the Nouvag website:

**[www.nouvag.com](http://www.nouvag.com) > Service > Service centers**

### 9.3 Bacteria filter

A periodical replacement of the bacteria filter is recommended after 8 hours of use, but definitely after it came into contact with foam or infectious material. For reordering refer to chapter 11 to retrieve the article number.

### 9.4 Secretion jar

The influxing mixture of air and secretion fluids into the secretion jar causes the build up of foam. It's recommended to use an antifoam agent to suppress the build up of foam. Prior use of the secretion jar fill an anti foam agent into the clean, dry jar. Don't use disinfection solution, because most of them benefit the build up of foam.

Make sure the secretion jars are in good condition. Check the jars routinely for cracks and rifts and be sure the jars flange is immaculate. It's important to guarantee full air tightness of the system which is responsible for troublefree operation of the pump.

### 9.5 Function control of float gauge valve

The proper functioning of the overflow protection system, built in the jar lid, has to be checked periodically.



1. Connect jar lid (VACUUM) with bacteria filter, using the connection tube (8 x 3 x 400 mm).
2. Turn Vacuum Controller clockwise (equivalent to vacuum maximum) all the way to the stop.
3. Press pneumatic pedal to generate vacuum.
4. Press the float gauge of the overflow protection system towards the lid.
5. The manometer shows increasing values up to the maximum. (> - 0.9 bar).



If the manometer doesn't show maximal vacuum (> - 0.9 bar), the overflow protection system has to be disassembled, cleaned and the seals have to be replaced.

## 9.6 Disassembly of the Overflow Protection System



1. Unscrew threaded Overflow Protection connector.
2. Remove seal from inside connector (O-Ring acc. picture).
3. Clean Overflow Protection System and float gauge.
4. Install new seal (O-Ring acc. picture).
5. Reassemble of Overflow Protection connector.

### Function control after reassembly:

6. Hold lid perpendicularly.
7. Press float gauge repeatedly towards the lid.
8. Float gauge must fall back in place by itself.

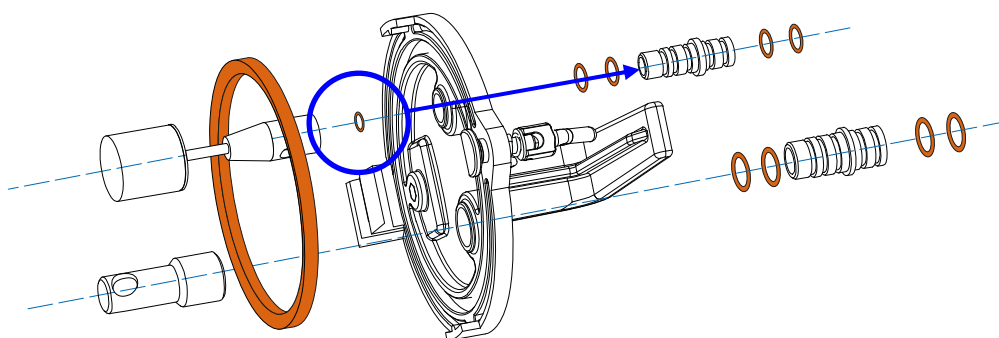

If the float gauge doesn't fall back in place by itself the cleaning procedure has to be repeated and the sitting of the O-Ring seal has to be checked and corrected.

## 9.7 Seals and tubes







To insure proper function of the Suction Pump, all tubes and seals must be periodically checked, and replaced after at most 250 sterilization cycles or five years of operation. Only when in perfect order can sufficient vacuum be built up.

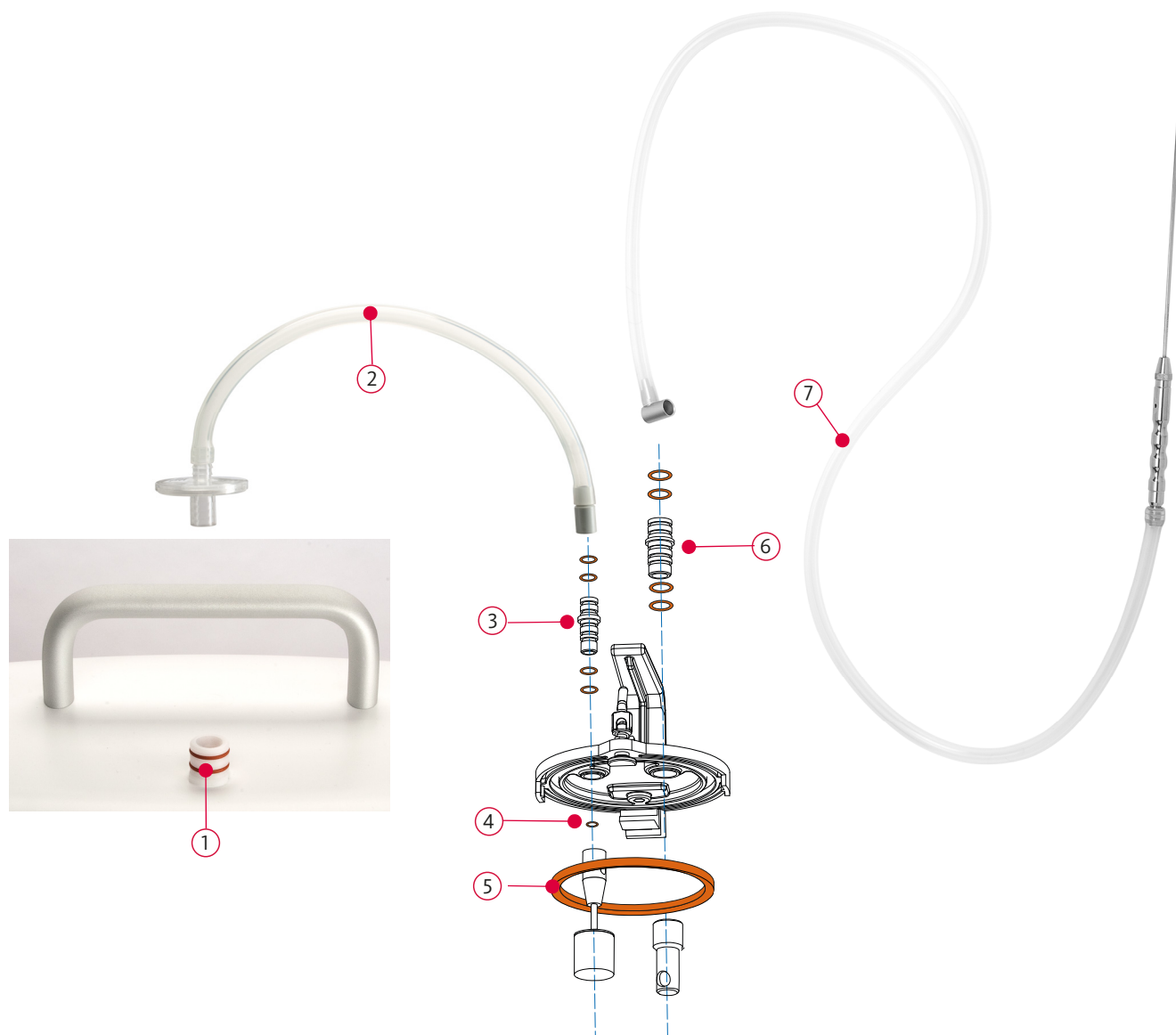

Defective seals and tubes must be replaced.

EN



- |   |  |
|---|--|
|  | 1. Seal (O-Ring) at intake nozzle of control unit for connection with bacteria filter -----2 units----- REF 4063 |
|  | 2. Connecting tube between bacteria filter and secretion jar lid (VACUUM)-----1 unit ----- REF 4155              |
|  | 3. Seal (O-Ring) at connection nozzle (unscrewable, VACUUM) at secretion jar lid -----4 units ----- REF 4064     |
|  | 4. Seal (O-Ring) at overflow protection system at jar lid-----1 unit ----- REF 28958                             |
|  | 5. Main seal between jar lid and jar -----1 unit ----- REF 28957   |
|  | 6. Seal (O-Ring) at connection nozzle (unscrewable, PATIENT) of secretion jar lid -----4 units ----- REF 4063    |
|  | 7. Filling tube between connection nozzle (PATIENT) and cannula -----1 unit ----- REF 4076                       |

## 10 Malfunction and troubleshooting

Malfunction	Cause	Solution	Reference in manual
<b>Device is not operational</b>	Pump is not switched on	Switch main switch "I/O" to "I"	7.1 Switching device on and off
	No connection to electricity-supply	Connect power cord to electricity-supply	6.4 Device preparation
	Wrong voltage	Check power supply of your Pump	6.2 Connection to the power supply
	Defective fuses	Replace fuse	9.1 Replacing the control unit fuse
<b>Pedal is not functioning</b>	On/Off-AIR-Pedal is not connected	Connect On/Off-AIR-Pedal with device at rear	7.2 Pump activation by pneumatic pedal
	Control unit is not switched on	Switch main switch "I/O" to "I"	7.1 Switching device on and off
	Incorrect operation	Read instruction manual carefully	
<b>Suction pump is not functioning</b>	Vacuum pump is not switched on	Connect On/Off-AIR-Pedal at the rear of the device	7.2 Pump activation by pneumatic pedal
	Vacuum-system is not air tight	Check all seals and tubes. Make sure char lid is properly closed	6.3 Preparation of secretion jar 6.4 Device preparation 9.7 Seals and tubes
	Air inlet port at rear of the device is open	Close air inlet port with its cap.	6.4 Device preparation
	Tubes are connected wrong	Connect tubes correctly	6.4 Device preparation
	Jar is full and Overflow protection has locked down	Replace full jar by a fresh, empty jar	7.5 Emptying secretion jar
	Incorrect operation	Read instruction manual carefully	
<b>Suction pump is not working properly</b>	Vacuum controller is not opened wide enough	Turn Vacuum controller clockwise	7.4 Regulating suction process
	Vacuum-system is not air tight	Check all seals and tubes. Make sure char lid is properly closed	6.3 Preparation of secretion jar 6.4 Device preparation 9.7 Seals and tubes

*If a fault cannot be rectified, please contact your supplier or an authorized service center. The addresses are provided on the last page of this operating instructions.*

## 11 Accessories and spare parts



### Seals

REF

(Refer to 9.7 Seals and tubes)



### Connection elements

REF

	Standard straight wide connector (PATIENT) at secretion jar lid, attached to filling tube -----	4056
	Standard straight narrow connector (VACUUM) at secretion jar lid, attached to connecting tube-----	4047
	Angled connector (VACUUM) for more convenient tube connection with filling tube-----	28535













### Tube elements

REF

	Connecting tube, Silicone, bacteria filter to jar lid, (Outer-Ø x inner-Ø x length) 8 x 3 x 400 mm-----	4155
	Connecting tube, Silicone, bacteria filter to jar lid, (Outer-Ø x inner-Ø x length) 8 x 3 x 500 mm-----	4190
	Single use filling tube Polypropylene, sterile, (Outer-Ø x inner-Ø x length) 6.5 x 9 x 4000 mm-----	6026





### Accessories





REF









	Secretion jar, 2 liter, polysulfone, sterilisable, including operation manual -----	4052
	Secretion jar, 5 liter, polysulfone, sterilisable, including operation manual-----	4245
	MONOKIT, secretion jar system with jars for 2 liter disposable pouches, with mounting bracket -----	4030
	MONOKIT, 2 liter disposable pouches including lid, 50 units-----	4035
	MONOKIT, 2 liter inlay jar, sterilisable-----	6036
	MONOKIT, mounting bracket for suspending the Monokit system-----	4037
	Bacteria filter for all NOUVAG Vacuson suction pumps, disposable, hydrophobe -----	4246
	Secretion jar lid with overflow protection system for 2 and 5 liter secretion jars, complete-----	4058
	Quiver, sterilizable, 30 cm length, with suspension device-----	4043
	Quiver, sterilizable, 40 cm length, with suspension device-----	4044
	Suction cups for obstetrics with Ø 60 mm-----	4053
	Suction cups for obstetrics with Ø 70 mm-----	4054
	Two way tap to switch between the two secretion jars, including connecting tube 8 x 3 x 400 mm-----	4130

### Suction Cannulas for Liposuction

REF

	Cannula handlebar with opening for false air ventilation -----	4391
	Cannula handlebar without opening -----	4390
	Yankauer suction cannula, length 28 cm, Ø 2.0 mm-----	4446
	Andrews cannula, length 24 cm, Ø 2.0 mm-----	4449

	Curved cannula for Femoral Liposuction, Ø 3 mm, length 200 mm, 22 openings 1.5 mm-----	4362
	Curved cannula for Femoral Liposuction, Ø 3 mm, length 300 mm, 30 openings 1.5 mm-----	4365
	Curved cannula for Femoral Liposuction, Ø 4 mm, length 200 mm, 22 openings 1.5 mm-----	4368
	Curved cannula for Femoral Liposuction, Ø 4 mm, length 300 mm, 30 openings 1.5 mm-----	4372
	Angled cannula, 30°, for Femoral Liposuction, Ø 3 mm, length 200 mm, 22 openings 1.5 mm-----	4381

	Straight cannula, Ø 1.5 mm, length 150 mm, 1 oval opening-----	4361
	Straight cannula, Ø 2 mm, length 150 mm, 1 oval opening-----	4364
	Straight cannula, Ø 2 mm, length 150 mm, 18 opening 1 mm-----	4373
	Straight cannula, Ø 3 mm, length 150 mm, 18 openings 1.5 mm-----	4374
	Straight cannula, Ø 3 mm, length 200 mm, 22 openings 1.5 mm-----	4378
	Straight cannula, Ø 3 mm, length 300 mm, 30 openings 1.5 mm-----	4387
	Straight cannula, Ø 4 mm, length 200 mm, 22 openings 2.0 mm-----	4379
	Straight cannula, Ø 4 mm, length 300 mm, 30 openings 1.5 mm-----	4388

### Infiltration cannula

REF

	Straight cannula, Ø 3 mm, length 250 mm-----	4350
---	--	------

To order additional parts, please contact our customer service department.

## 12 Information on disposal

---

When disposing of the device, device parts and accessories, the regulations prescribed by law must be observed.

Do not dispose of devices with household waste!

To ensure environmental protection, old devices can be returned to the dealer or manufacturer.



Motors that have reached the end of their service life may not be disposed of with household waste. Motors must be sterilized before disposal. Please observe currently valid national disposal regulations for infectious waste.



Contaminated single-use tubing sets are subject to specific disposal requirements. Please observe currently valid national disposal regulations for infectious waste.